





## Micro injection Needles



The perfect and accurate grinding of needles significantly reduced pain sensation during the treatment.



## Blunt needle



Precision micro-cannulas are based on high technology and innovations, which makes it ideal for precise procedures. device designed for nappage in areas such as the face, arms and breast and is used like usual lipofiling.

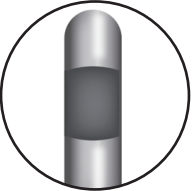

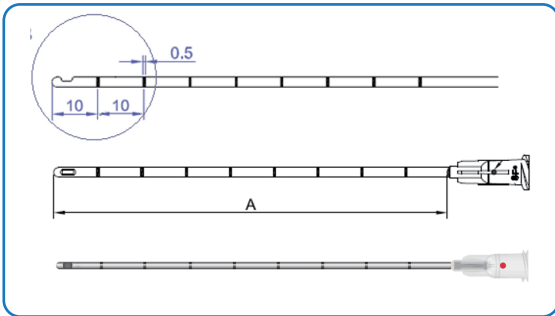

A graduated design for greater precision

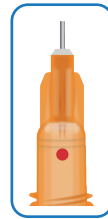

A clear orifice indicator for more control



A Luer Lock base for greater resistance

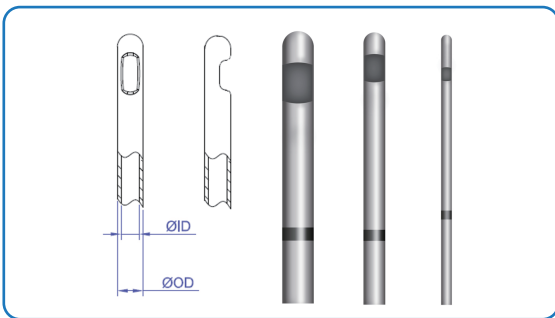

A round tip for greater safety

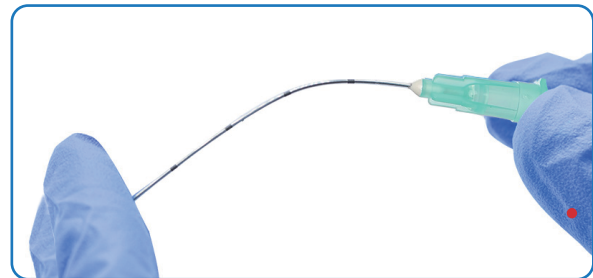

Flexible Cannula

## CANNULA SPECIFICATION

Cannula Size (Blunt needle)				Cannula Color	Matched Sharp Needle Size (Sharp needle)	Needle Color
Gauge	Length	O.D	I.D			
21G	50MM	0.81	0.56	Green	20GX25MM	Yellow
	70MM					
22G	50MM	0.70	0.48	Black	20GX25MM	Yellow
	70MM					
23G	38MM	0.60	0.39	Blue	22GX25MM	Black
	50MM					
	70MM					
25G	38MM	0.80	0.28	Orange	23GX25MM	Blue
	50MM	0.50				
27G	38MM	0.40	0.22	Grey	25GX25MM	Orange
	50MM					
30G	25MM	0.30	0.17	Yellow	25GX25MM	Orange